

IND360xx

Weighing Terminal



METTLER TOLEDO

IND360xx Weighing Terminal

METTLER TOLEDO Service

Essential Services for Dependable Performance of Your IND360xx Weighing Terminal

Congratulations on choosing the quality and precision of METTLER TOLEDO. Proper use of your new equipment according to this Manual and regular calibration and maintenance by our factory-trained service team ensures dependable and accurate operation, protecting your investment. Contact us about a service agreement tailored to your needs and budget. Further information is available at www.mt.com/service.

There are several important ways to ensure you maximize the performance of your investment:

1. **Register your product:** We invite you to register your product at www.mt.com/productregistration so we can contact you about enhancements, updates and important notifications concerning your product.
2. **Contact METTLER TOLEDO for service:** The value of a measurement is proportional to its accuracy – an out of specification scale can diminish quality, reduce profits and increase liability. Timely service from METTLER TOLEDO will ensure accuracy and optimize uptime and equipment life.
 - a. **Installation, Configuration, Integration and Training:** Our service representatives are factory-trained, weighing equipment experts. We make certain that your weighing equipment is ready for production in a cost effective and timely fashion and that personnel are trained for success.
 - b. **Initial Calibration Documentation:** The installation environment and application requirements are unique for every industrial scale so performance must be tested and certified. Our calibration services and certificates document accuracy to ensure production quality and provide a quality system record of performance.
 - c. **Periodic Calibration Maintenance:** A Calibration Service Agreement provides on-going confidence in your weighing process and documentation of compliance with requirements. We offer a variety of service plans that are scheduled to meet your needs and designed to fit your budget.
 - d. **GWP® Verification:** A risk-based approach for managing weighing equipment allows for control and improvement of the entire measuring process, which ensures reproducible product quality and minimizes process costs. GWP (Good Weighing Practice), the science-based standard for efficient life-cycle management of weighing equipment, gives clear answers about how to specify, calibrate and ensure accuracy of weighing equipment, independent of make or brand.

© METTLER TOLEDO 2023

No part of this manual may be reproduced or transmitted in any form or by any means, electronic or mechanical, including photocopying and recording, for any purpose without the express written permission of METTLER TOLEDO.

U.S. Government Restricted Rights: This documentation is furnished with Restricted Rights.

Copyright 2023 METTLER TOLEDO. This documentation contains proprietary information of METTLER TOLEDO. It may not be copied in whole or in part without the express written consent of METTLER TOLEDO.

METTLER TOLEDO reserves the right to make refinements or changes to the product or manual without notice.

NOTICE

This document is associated with an agency-approved product. No changes to this document are permitted without agency approval.

ORDERING INFORMATION

It is most important that the correct part number is used when ordering parts. Parts orders are machine processed, using only the part number and quantity as shown on the order. Orders are not edited to determine if the part number and description agree.

COPYRIGHT

METTLER TOLEDO® is a registered trademark of Mettler-Toledo, LLC. All other brand or product names are trademarks or registered trademarks of their respective companies.

METTLER TOLEDO RESERVES THE RIGHT TO MAKE REFINEMENTS OR CHANGES WITHOUT NOTICE.

FCC Notice











This device complies with Part 15 of the FCC Rules and the Radio Interference Requirements of the Canadian Department of Communications. Operation is subject to the following conditions: (1) this device may not cause harmful interference, and (2) this device must accept any interference received, including interference that may cause undesired operation.



















This equipment has been tested and found to comply with the limits for a Class A digital device, pursuant to Part 15 of FCC Rules. These limits are designed to provide reasonable protection against harmful interference when the equipment is operated in a commercial environment. This equipment generates, uses, and can radiate radio frequency energy and, if not installed and used in accordance with the instruction manual, may cause harmful interference to radio communications. Operation of this equipment in a residential area is likely to cause harmful interference in which case the user will be required to correct the interference at his or her expense.



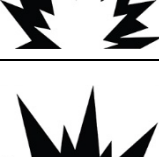

- Declaration of Conformity is available at <http://glo.mt.com/global/en/home/search/compliance.html/compliance/>.

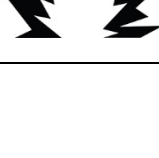
Warnings and Cautions

- READ this manual BEFORE operating or servicing this equipment and FOLLOW these instructions carefully.
- SAVE this manual for future reference.
- DO NOT allow untrained personnel to operate, clean, inspect, maintain, service or tamper with this equipment.
- ALWAYS DISCONNECT this equipment from the power source before cleaning or performing maintenance.
- CALL METTLER TOLEDO for parts, information and accessories.

	<p style="text-align: center;"> WARNING</p> <p>METTLER TOLEDO ASSUMES NO RESPONSIBILITY FOR CORRECT INSTALLATION OF THIS EQUIPMENT WITHIN A ZONE 2 / ZONE 22 / DIVISION 2 AREA. THE INSTALLER MUST BE FAMILIAR WITH ALL ZONE 2 / ZONE 22 / DIVISION 2 WIRING AND INSTALLATION REQUIREMENTS.</p>
	<p style="text-align: center;"> WARNING</p> <p>DO NOT USE THE IND360xx ANALOG / IND360xx POWERCELL / IND360xx PRECISION TERMINAL WITHIN AREAS CLASSIFIED AS HAZARDOUS DIVISION 1 OR ZONE 0/1/20/21 BECAUSE OF COMBUSTIBLE OR EXPLOSIVE ATMOSPHERES. FAILURE TO COMPLY WITH THIS WARNING COULD RESULT IN BODILY HARM AND/OR PROPERTY DAMAGE.</p>
	<p style="text-align: center;"> WARNING</p> <p>THE IND360xx ANALOG / IND360xx POWERCELL / IND360xx PRECISION WEIGHING TERMINAL HAS A TEMPERATURE RATING OF T4 (135° C) FOR GAS IN A ZONE 2 / DIVISION 2 ENVIRONMENT. IT MUST NOT BE USED IN AREAS WHERE THE AUTO IGNITION TEMPERATURE OF THE HAZARDOUS MATERIAL IS BELOW THIS RATING.</p>
	<p style="text-align: center;"> WARNING</p> <p>ONLY THE COMPONENTS SPECIFIED IN THIS MANUAL CAN BE USED IN THIS WEIGHING TERMINAL. ALL EQUIPMENT MUST BE INSTALLED IN ACCORDANCE WITH THE INSTALLATION INSTRUCTIONS DETAILED IN THIS MANUAL. INCORRECT OR SUBSTITUTE COMPONENTS AND/OR DEVIATION FROM THESE INSTRUCTIONS CAN IMPAIR THE SAFETY OF THE WEIGHING TERMINAL AND COULD RESULT IN BODILY INJURY AND/OR PROPERTY DAMAGE.</p>
	<p style="text-align: center;"> WARNING</p> <p>VERSIONS OF THE IND360xx ANALOG / IND360xx POWERCELL / IND360xx PRECISION WEIGHING TERMINAL THAT ARE NOT FACTORY-LABELED AS ZONE 2 MUST NOT BE INSTALLED INTO A ZONE 2 ENVIRONMENT. VERSIONS FACTORY LABELED AS DIVISION 2 OF THE IND360xx ANALOG / IND360xx POWERCELL / IND360xx PRECISION WEIGHING TERMINAL CAN BE INSTALLED IN A DIVISION 2 ENVIRONMENT.</p>

	<p style="text-align: center;"> WARNING</p> <p>IN ORDER TO INSTALL THE IND360xx TERMINAL IN THE US OR CANADA, METTLER TOLEDO CONTROL DRAWINGS 30630824 OR 30630826 OR 30630828 / INSTALLATION DRAWINGS 30630825 OR 30630827 OR 30630829 MUST BE FOLLOWED WITHOUT EXCEPTION. FAILURE TO DO SO COULD RESULT IN BODILY HARM AND/OR PROPERTY DAMAGE.</p>
	<p style="text-align: center;"> WARNING</p> <p>THE IND360xx ANALOG / IND360xx POWERCELL / IND360xx PRECISION WEIGHING TERMINAL MUST BE INSTALLED AND MAINTAINED PER THE SPECIAL CONDITIONS LISTED IN CHAPTER 3 OF THIS MANUAL WITHOUT EXCEPTION. FAILURE TO DO SO COULD RESULT IN BODILY HARM AND/OR PROPERTY DAMAGE.</p>
	<p style="text-align: center;"> WARNING</p> <p>DO NOT INSTALL, DISCONNECT OR PERFORM ANY SERVICE ON THIS EQUIPMENT BEFORE POWER HAS BEEN SWITCHED OFF AND THE AREA HAS BEEN SECURED AS NON-HAZARDOUS BY PERSONNEL AUTHORIZED TO DO SO BY THE RESPONSIBLE PERSON ON-SITE.</p>
	<p style="text-align: center;"> WARNING</p> <p>DO NOT REMOVE OR REPLACE WHILE CIRCUIT IS LIVE UNLESS THE AREA IS KNOWN TO BE FREE OF IGNITABLE CONCENTRATIONS OF FLAMMABLE SUBSTANCES.</p>
	<p style="text-align: center;"> WARNING</p> <p>THE DIN ENCLOSURE VERSIONS OF THE EQUIPMENT ARE COMPONENT CERTIFIED AND AS A SPECIFIC CONDITION OF USE MUST BE INSTALLED IN A TOOL SECURED FINAL EQUIPMENT ENCLOSURE AND NOT TO OPEN THE ENCLOSURE UNTIL THE AREA IS KNOWN TO BE FREE OF HAZARDOUS GASES AND DUSTS.</p>
	<p style="text-align: center;"> WARNING</p> <p>STATIC ELECTRICITY HAZARD! ONLY CLEAN WITH A DAMP CLOTH! FOLLOW THE MANUFACTURER'S INSTRUCTIONS, AVOID STATIC ELECTRICITY.</p>
	<p style="text-align: center;"> WARNING</p> <p>INDOOR USE ONLY.</p>
	<p style="text-align: center;"> WARNING</p> <p>THE BATTERY(MODEL CR2032) CAN BE REPLACABLE ONLY WHEN IND360 IS POWERED OFF AND LOCATED IN SAFE AREA.</p>
	<p style="text-align: center;"> WARNING</p> <p>RESISTANCE MEASURES TO ULTRAVIOLET LIGHT MUST PROVIDE.</p>

	<p style="text-align: center;"> WARNING</p>
	<p style="text-align: center;"> WARNING</p>
	<p style="text-align: center;"><i>NOTICE</i></p>
	<p style="text-align: center;">OBSERVE PRECAUTIONS FOR HANDLING ELECTROSTATIC SENSITIVE DEVICES.</p>

Disposal of Electrical and Electronic Equipment

In conformance with the European Directive 2012/19/EC on Waste Electrical and Electronic Equipment (WEEE) this device may not be disposed of in domestic waste. This also applies to countries outside the EU, per their specific requirements.



Please dispose of this product in accordance with local regulations at the collecting point specified for electrical and electronic equipment.

If you have any questions, please contact the responsible authority or the distributor from which you purchased this device.

Should this device be passed on to other parties (for private or professional use), the content of this regulation must also be related.

Thank you for your contribution to environmental protection.

Contents

1	Introduction.....	1-1
1.1.	Overview	1-1
1.2.	FM Approvals	1-1
1.3.	Product Markings.....	1-2
2	Installation.....	2-1
2.1.	Before Installation	2-1
2.2.	Non-incendive (NI) Approval	2-1
2.3.	Associated Non-Incendive (ANI) approval.....	2-3
2.4.	Increased safety (ec) Approval.....	2-3
2.5.	Intrinsic safety (ic) approval	2-3
2.6.	Temperature Rating	2-3
2.7.	Division 2 Application Example Using Load Cells	2-4
2.8.	Installation Procedure	2-6
3	Special Requirements	3-1
3.1.	Enclosure	3-1
3.2.	Areas with Different Classifications.....	3-1
3.3.	Special Conditions of Use.....	3-1
A.	Approval Documents	A-1
A.1.	Approval Documents	A-1
A.2.	Control Drawing (US and Canada), Analog.....	A-3
A.3.	Control Drawing (US and Canada), POWERCELL	A-6
A.4.	Control Drawing (US and Canada), Precision	A-9
A.5.	Global and International (ATEX/UKEX and IECEx), Analog	A-12
A.6.	Global and International (ATEX/UKEX and IECEx), POWERCELL	A-14
A.7.	Global and International (ATEX/UKEX and IECEx), Precision.....	A-16



1 Introduction

1.1. Overview

This installation guide describes some basic concepts about Division 2 and Zone 2/22 hazardous areas and provides guidelines for installing IND360xx Analog / IND360xx POWERCELL / IND360xx Precision Weighing Terminal.

ATEX and IECEx certified versions of the IND360xx Analog / IND360xx POWERCELL / IND360xx Precision Weighing Terminal are approved for installation and use in Zone 2 areas.

For the Harsh and DIN versions, the IND360xx Analog / IND360xx POWERCELL / IND360xx Precision can be used with load cells located in Division 2 and Zone 2/22 hazardous areas without the use of a barrier, the POWERCELL IND360xx should be installed per NEC division 2 wiring methods, NIFW wiring method can't use; for the Panel version, the Analog /Precision IND360xx are approved as Associated Non-Incendive Field wiring apparatus. The terminal must be installed in a non-hazardous area.

	 WARNING
	METTLER TOLEDO ASSUMES NO RESPONSIBILITY FOR CORRECT INSTALLATION OF THIS EQUIPMENT WITHIN A ZONE 2 / ZONE 22 / DIVISION 2 AREA. THE INSTALLER MUST BE FAMILIAR WITH ALL ZONE 2 / ZONE 22 / DIVISION 2 WIRING AND INSTALLATION REQUIREMENTS.

1.2. FM Approvals

The approval by FM Approvals applies to:



- Zone 2/Zone 22/Division 2 application that require compliance to National Electrical Code (NEC) in the United States
- Zone 2/Zone 22/Division 2 application that require compliance to Canadian Electric Code (CEC) in Canada
- The passing of the Load cell connections from a non-hazardous area to a Zone 2/ Zone 22/ Division 2 location per the National Electrical Code (NEC) in the United States.
- The passing of the Load cell connections from a non-hazardous area to a Zone 2/ Zone 22/ Division 2 location per the Canadian Electric Code (CEC) in Canada.

The approval by FM applies to:

- Zone 2/ Zone 22 applications that require compliance to European/UK IEC 60079-14.

- Zone 2/ Zone 22 applications installed to standard IEC 60079-14.

These approvals may also be acceptable in other worldwide locations. Confirm the acceptance of these approvals with the customer or with local authorities before installation. Regardless of the installation location, all local and national wiring and installation requirements must be followed during installation.

	 WARNING
	IN ORDER TO INSTALL THE IND360xx TERMINAL IN THE US OR CANADA, METTLER TOLEDO CONTROL DRAWINGS 30630824 OR 30630826 OR 30630828 / INSTALLATION DRAWINGS 30630825 OR 30630827 OR 30630829 MUST BE FOLLOWED WITHOUT EXCEPTION. FAILURE TO DO SO COULD RESULT IN BODILY HARM AND/OR PROPERTY DAMAGE.

1.3. Product Markings

Due to special conditions associated with the approval of the IND360xx Analog/ IND360xx POWERCELL/IND360xx Precision Weighing Terminal to U.S. and Canadian standards as well as the ATEX/UKCA and IECEx standards, not all versions of the IND360xx Weighing Terminal are identically marked.

When ordering an IND360xx Weighing Terminal, it is important to know which approval markings are required. Please have this information available for the local authorized METTLER TOLEDO sales representative.

1.3.1. U.S. Approval

The IND360xx Analog / IND360xx POWERCELL / IND360xx Precision Weighing Terminals have been approved by FM Approvals (FM22US0002U and FM22US0001X), and include the following markings:

1.3.1.1. IND360xx Analog

DIN

FM22US0002U

NI / I / 2 / CD, Ta = -10°C to 40°C

ANI / I, II, III / 2 / CDFG NIFW 30630824

I / 2 / AEx ec [ic] IIB Gc, Ta = -10°C to 40°C- 30630824 Entity

Entity / NIFW: Uo = 5.14Vdc, Io = 222mA, Po = 1.14W, Lo = 0.43mH, Co = 1µF

Panel

FM22US0001X

ANI / I, II, III / 2 / CDFG NIFW 30630824

Entity / NIFW: Uo = 5.14Vdc, Io = 222mA, Po = 1.14W, Lo = 0.43mH, Co = 1µF

Harsh

FM22US0001X

NI / I, II, III / 2 / CDFG, T4, Ta = -10°C to 40°C; IP65

ANI / I, II, III / 2 / CDFG NIFW 30630824

I / 2 / AEx ec [ic] IIB T4 Gc, Ta = -10°C to 40°C- 30630824; Entity; IP65

II, III / 22 / AEx tc IIIC T80°C Dc, Ta = -10°C to 40°C; IP65

Entity / NIFW: Uo = 5.14Vdc, Io = 222mA, Po = 1.14W, Lo = 0.43mH, Co = 1µF

1.3.1.2. IND360xx POWERCELL

DIN

FM22US0002U

NI / I / 2 / CD, Ta = -10°C to 40°C

I / 2 / AEx ec IIB Gc, Ta = -10°C to 40°C

Harsh

FM22US0001X

NI / I, II, III / 2 / CDFG, T4, Ta = -10°C to 40°C; IP65

I / 2 / AEx ec IIB T4 Gc, Ta = -10°C to 40°C; IP65

II, III / 22 / AEx tc IIIC T80°C Dc, Ta = -10°C to 40°C; IP65

1.3.1.3. IND360xx Precision

DIN

FM22US0002U

NI / I / 2 / ABCD, Ta = -10°C to 40°C

ANI / I, II, III / 2 / ABCDFG NIFW 30630828

I / 2 / AEx ec IIC Gc, Ta = -10°C to 40°C

NIFW:

+12V: Uo = 12.36Vdc, Io = 255mA, Po = 3.15W, Lo = 0.12mH, Co = 1µF

TXD+ & TXD-: Uo = 3.5VDC, Io = 250mA, Po = 875mW, Lo = 0.5mH, Co = 5µF

TxD: Uo = 13.2 VDC, Io = 60mA, Po = 792mW, Lo = 0.5mH, Co = 0.8µF

Panel

FM22US0001X

ANI / I, II, III / 2 / ABCDFG NIFW 30630828

NIFW:

+12V: Uo = 12.36Vdc, Io = 255mA, Po = 3.15W, Lo = 0.12mH, Co = 1µF

TXD+ & TXD-: $U_o = 3.5\text{VDC}$, $I_o = 250\text{mA}$, $P_o = 875\text{mW}$, $L_o = 0.5\text{mH}$, $C_o = 5\mu\text{F}$

TxD: $U_o = 13.2\text{VDC}$, $I_o = 60\text{mA}$, $P_o = 792\text{mW}$, $L_o = 0.5\text{mH}$, $C_o = 0.8\mu\text{F}$

Harsh

FM22US0001X

NI / I, II, III / 2 / ABCDFG, T4, $T_a = -10^\circ\text{C}$ to 40°C ; IP65

ANI / I, II, III / 2 / ABCDFG NIFW 30630828

I / 2 / AEx ec IIC T4 Gc, $T_a = -10^\circ\text{C}$ to 40°C ; IP65

II, III / 22 / AEx tc IIIC T80°C Dc, $T_a = -10^\circ\text{C}$ to 40°C ; IP65

NIFW:

+12V: $U_o = 12.36\text{Vdc}$, $I_o = 255\text{mA}$, $P_o = 3.15\text{W}$, $L_o = 0.12\text{mH}$, $C_o = 1\mu\text{F}$

TXD+ & TXD-: $U_o = 3.5\text{VDC}$, $I_o = 250\text{mA}$, $P_o = 875\text{mW}$, $L_o = 0.5\text{mH}$, $C_o = 5\mu\text{F}$

TxD: $U_o = 13.2\text{VDC}$, $I_o = 60\text{mA}$, $P_o = 792\text{mW}$, $L_o = 0.5\text{mH}$, $C_o = 0.8\mu\text{F}$

- All approved versions must be installed per METTLER TOLEDO control drawings 30630824 (IND360xx Analog) or 30630826 (IND360xx POWERCELL) or 30630828 (IND360xx Precision) without exception.

1.3.2. Canadian Approval

The IND360xx Analog / IND360xx POWERCELL / IND360xx Precision Weighing Terminals have been approved by FM Approvals (FM22CA0002U and FM22CA0001X), include the following markings:

1.3.2.1. IND360xx Analog

DIN

FM22CA0002U

NI / I / 2 / CD, $T_a = -10^\circ\text{C}$ to 40°C

ANI / I, II, III / 2 / CDFG NIFW 30630824

2 / Ex ec [ic] IIB Gc, $T_a = -10^\circ\text{C}$ to 40°C - 30630824 Entity

Entity / NIFW: $U_o = 5.14\text{Vdc}$, $I_o = 222\text{mA}$, $P_o = 1.14\text{W}$, $L_o = 0.43\text{mH}$, $C_o = 1\mu\text{F}$

Panel

FM22CA0001X

ANI / I, II, III / 2 / CDFG NIFW 30630824

Entity / NIFW: $U_o = 5.14\text{Vdc}$, $I_o = 222\text{mA}$, $P_o = 1.14\text{W}$, $L_o = 0.43\text{mH}$, $C_o = 1\mu\text{F}$

Harsh

FM22CA0001X

NI / I, II, III / 2 / CDFG, T4, $T_a = -10^\circ\text{C}$ to 40°C ; IP65

ANI / I, II, III / 2 / CDFG NIFW 30630824

2 / Ex ec [ic] IIB T4 Gc, Ta = -10°C to 40°C- 30630824; Entity; IP65
22 / Ex tc IIIC T80°C Dc, Ta = -10°C to 40°C; IP65
Entity / NIFW: Uo = 5.14Vdc, Io = 222mA, Po = 1.14W, Lo = 0.6mH, Co = 1µF

1.3.2.2. IND360xx POWERCELL

DIN

FM22CA0002U

NI / I / 2 / CD Ta = -10°C to 40°C
2 / Ex ec IIB Gc, Ta = -10°C to 40°C

Harsh

FM22CA0001X

NI / I, II, III / 2 / CDFG, T4, Ta = -10°C to 40°C; IP65
2 / Ex ec IIB T4 Gc, Ta = -10°C to 40°C; IP65
22 / Ex tc IIIC T80°C Dc, Ta = -10°C to 40°C; IP65

1.3.2.3. IND360xx Precision

DIN

FM22CA0002U

NI / I / 2 / ABCD, Ta = -10°C to 40°C
ANI / I, II, III / 2 / ABCDFG NIFW 30630828
2 / Ex ec IIC Gc, Ta = -10°C to 40°C

NIFW:

+12V: Uo = 12.36Vdc, Io = 255mA, Po = 3.15W, Lo = 0.12mH, Co = 1µF
TXD+ & TXD-: Uo = 3.5VDC, Io = 250mA, Po = 875mW, Lo = 0.5mH, Co = 5µF
TxD: Uo = 13.2 VDC, Io = 60mA, Po = 792mW, Lo = 0.5mH, Co = 0.8uF

Panel

FM22CA0001X

ANI / I, II, III / 2 / ABCDFG NIFW 30630828

NIFW:

+12V: Uo = 12.36Vdc, Io = 255mA, Po = 3.15W, Lo = 0.12mH, Co = 1µF
TXD+ & TXD-: Uo = 3.5VDC, Io = 250mA, Po = 875mW, Lo = 0.5mH, Co = 5µF
TxD: Uo = 13.2 VDC, Io = 60mA, Po = 792mW, Lo = 0.5mH, Co = 0.8uF

Harsh**FM22CA0001X**

NI / I, II, III / 2 / ABCDFG, T4, Ta = -10°C to 40°C; IP65

ANI / I, II, III / 2 / ABCDFG NIFW 30630828

2 / Ex ec IIC T4 Gc, Ta = -10°C to 40°C; IP65

22 / Ex tc IIIC T80°C Dc, Ta = -10°C to 40°C; IP65

NIFW:

+12V: Uo = 12.36Vdc, Io = 255mA, Po = 3.15W, Lo = 0.12mH, Co = 1µF

TXD+ & TXD-: Uo = 3.5VDC, Io = 250mA, Po = 875mW, Lo = 0.5mH, Co = 5µF

TxD: Uo = 13.2 VDC, Io = 60mA, Po = 792mW, Lo = 0.5mH, Co = 0.8µF

- All approved versions must be installed per METTLER TOLEDO control drawings 30630824 (IND360xx Analog) or 30630826 (IND360xx POWERCELL) or 30630828 (IND360xx Precision) without exception.

1.3.3. European ATEX & UKCA Approval

The IND360xx Analog / IND360xx POWERCELL / IND360xx Precision Weighing Terminals have been approved by FM22ATEX0002U, FM22ATEX0001X and FM22UKEX0002U, FM22UKEX0001X. This authorizes METTLER TOLEDO to mark the Weighing Terminal as:

1.3.3.1. IND360xx Analog

DIN**FM22ATEX0002U, FM22UKEX0002U**

II 3 G Ex ec [ic] IIB Gc, Ta = -10°C to 40°C- 30630825

Uo = 5.14Vdc, Io = 222mA, Po = 1.14W, Lo = 0.43mH, Co = 1µF

Harsh**FM22ATEX0001X, FM22UKEX0001X**

II 3 G Ex ec [ic] IIB T4 Gc, Ta = -10°C to 40°C- 30630825

II 3 D Ex tc IIIC T80°C Dc, Ta = -10°C to 40°C; IP65

Uo = 5.14Vdc, Io = 222mA, Po = 1.14W, Lo = 0.43mH, Co = 1µF

1.3.3.2. IND360xx POWERCELL

DIN**FM22ATEX0002U, FM22UKEX0002U**

II 3 G Ex ec IIB Gc, Ta = -10°C to 40°C- 30630827

Harsh



FM22ATEX0001X, FM22UKEX0001X

II 3 G Ex ec IIB T4 Gc, Ta = -10°C to 40°C- 30630827

II 3 D Ex tc IIIC T80°C Dc, Ta = -10°C to 40°C; IP65

1.3.3.3. IND360xx Precision

DIN



FM22ATEX0002U, FM22UKEX0002U

II 3 G Ex ec IIC Gc, Ta = -10°C to 40°C- 30630829

Harsh



FM22ATEX0001X, FM22UKEX0001X

II 3 G Ex ec IIC T4 Gc, Ta = -10°C to 40°C- 30630829

II 3 D Ex tc IIIC T80°C Dc, Ta = -10°C to 40°C; IP65

1.3.4. Global IECEx Approval

The IND360xx Analog / IND360xx POWERCELL / IND360xx Precision Weighing Terminals have been approved by IECEx FMG 22.0002U and IECEx FMG 22.0001X. This authorizes METTLER TOLEDO to mark the Weighing Terminal as:

1.3.4.1. IND360xx Analog

DIN

Ex ec [ic] IIB Gc

Ta= -10°C...+40°C

Harsh

Ex ec [ic] IIB T4 Gc

Ex tc IIIC T80°C Dc

Ta= -10°C...+40°C, IP65

1.3.4.2. IND360xx POWERCELL

DIN

Ex ec IIB Gc

Ta= -10°C...+40°C

Harsh

Ex ec IIB T4 Gc

Ex tc IIIC T80°C Dc

Ta= -10°C...+40°C, IP65

1.3.4.3. IND360xx Precision

DIN

Ex ec IIC Gc

Ta= -10°C...+40°C

Harsh

Ex ec IIC T4 Gc

II 3 D Ex tc IIIC T80°C Dc

Ta= -10°C...+40°C, IP65

2 Installation

2.1. Before Installation

Before installing the IND360xx Analog / IND360xx POWERCELL / IND360xx Precision Weighing Terminal in the US and Canada, read and understand METTLER TOLEDO control drawings 30630824 (IND360xx Analog) or 30630826 (IND360xx POWERCELL) or 30630828 (IND360xx Precision), included in the appendix of this guide.

Before installing the Category 3 rated IND360xx Analog / IND360xx POWERCELL / IND360xx Precision Weighing Terminals into an area classified as Zone 2 / Zone 22 according to the European/UK, read and understand METTLER TOLEDO installation drawing, 30630825 (IND360xx Analog) or 30630827 (IND360xx POWERCELL) or 30630829 (IND360xx Precision), and the specific conditions of use listed on Type Examination Certificate FM22ATEX0002U , FM22ATEX0001X and FM22UKEX0002U, FM22UKEX0001X included in the appendix of this guide.

For installation in an ATEX /IECEX / UKCA Zone 2 / Zone 22 location, the DIN version of IND360xx Analog / IND360xx POWERCELL / IND360xx Precision weighing terminals must be installed into an approved enclosure with a minimum IP54 rating (not included). The Harsh version of IND360xx Analog / IND360xx POWERCELL / IND360xx Precision weighing terminals can be installed into Zone 22 location directly.

Before beginning the installation, confirm that the correct markings are on the IND360xx Analog / IND360xx POWERCELL / IND360xx Precision Weighing Terminal indicating that the Weighing Terminal has been approved for use in Zone 2/Zone 22 areas. The markings are shown in section 1.3 of this guide.

If the IND360xx Weighing Terminal does not include the approval markings as shown in section 1.3 of this guide, the Weighing Terminal cannot be installed in the hazardous area.

2.2. Non-incendive (NI) Approval

The IND360xx Analog / IND360xx Precision Weighing Terminal for the United States and Canada have been approved as Non-Incendive protected Apparatus and can be installed in Division 2 areas. Refer to the National Electrical Code, Canadian Electrical Code, or applicable local ordinance for allowed wiring methods.

2.2.1. Analog Load Cell Connection

The IND360xx Analog Weighing Terminal analog load cell connection is rated as non-incendive. Load cells must be connected according to details shown in drawing 30630824.

IND360xx Analog Weighing Terminal can use the Non-incendive field wiring (NIFW) method for Division 2 installations.

The non-incendive parameters are listed in the table below.

Table 2-1: Non-Incendive Field Wiring Parameters

NIFW Parameters
$V_{oc} = 5.14 \text{ VDC}$
$I_{sc} = 222 \text{ mA}$
$C_a = 1 \text{ }\mu\text{F}$
$L_a = 0.43 \text{ mH}$

2.2.2. POWERCELL Digital Load Cell Connection

The digital POWERCELL load cell connection is rated non-incendive on the IND360xx POWERCELL Weighing Terminal. This interface uses a power supply and bi-directional communication lines in separate NI Circuits. Connection of the POWERCELL Digital Load Cells must be per the details shown on drawing 30630826.

To reach non-incendive protection requirements the wiring method of IND360xx POWERCELL Weighing Terminal must comply with NEC DIVISION 2 WIRING METHODS.

The IND360xx POWERCELL Weighing Terminal parameters are listed in the table below.

Table 2-2: POWERCELL Load Cell Connection Parameters

Parameters	Power Circuit	Communications (Transmitting)	Communications (Receiving)
Voc	12.4 VDC	5.47 VDC	
Isc	1182 mA	200 mA	
Vmax			26.8 VDC

2.2.3. Precision Load Cell Connection

The Precision load cell connection is rated non-incendive on the IND360xx Precision Weighing Terminal. This interface uses a power supply and bi-directional communication lines in separate NIFW Circuits. Connection of the precision Load Cells must be per the details shown on drawing 30630828.

The non-incendive parameters of IND360xx Precision Weighing Terminal are listed in the table below.

Table 2-3: IND360xx Precision Non-Incendive Parameters

NIFW Parameters	SICSPro Power	SICSPro RS422 (Transmitting)	SICSPro RS232 (Transmitting)
Voc	12.36 VDC	3.5 VDC	13.2 VDC
Isc	255 mA	250 mA	60 mA

NIFW Parameters	SICSPro Power	SICSPro RS422 (Transmitting)	SICSPro RS232 (Transmitting)
Ca	1.0 μ F	5.0 μ F	0.8 μ F
La	0.12 mH	0.5 mH	0.5 mH

NIFW Parameters	SICSPro RS422 (Receiving)	SICSPro RS232 (Receiving)
Vmax	-7V...+12 VDC	\pm 25 VDC
Ci	1.56 nF	735 pF
Li	0 mH	0

2.3. Associated Non-Incendive (ANI) approval

The IND360xx Analog / IND360xx Precision Weighing Terminal has been approved as an Associated Non-Incendive (ANI) apparatus. This permits the equipment to work as an associated apparatus which must be installed in non-classified (safe) area.

Note that, the Panel versions of IND360xx Analog / IND360xx Precision Weighing Terminal have been approved only as Associated Non-Incendive (ANI) apparatuses. This means the panel versions of IND360xx Analog / IND360xx Precision Weighing Terminal must only be installed in non-classified (safe) area.

2.4. Increased safety (ec) Approval

The IND360xx Analog / IND360xx POWERCELL / IND360xx Precision have been approved as increased safety devices for Zone 2 environments. This permits the equipment to be physically located within a Zone 2 area. Note that load cell/s in the platform must also have an increased safety (ec) approval, and the terminal must not exceed the maximum supply voltage listed on the certificate.

2.5. Intrinsic safety (ic) approval

The IND360xx Analog has been approved as an ex ic device for Zone 2 environments. This permits the equipment to be physically located within a Zone 2 area. Note that the load cell/s in the platform must also have an ex ic approval, and the terminal must not exceed the maximum supply voltage listed on the certificate.

2.6. Temperature Rating

It is important that the temperature rating of the IND360xx Analog / IND360xx POWERCELL / IND360xx Precision Weighing Terminal be appropriate for the environment in which it will be used. The IND360xx Analog / IND360xx POWERCELL / IND360xx Precision Weighing Terminal has been

approved with a temperature rating of T4 (135°C) for gas. In order to be safe, this value must be lower than the Auto Ignition Temperature (AIT) of the hazardous product. If the AIT of the hazardous product is lower than the temperature rating of the IND360xx Analog / IND360xx POWERCELL / IND360xx Precision Weighing Terminal, the IND360xx Analog / IND360xx POWERCELL / IND360xx Precision Weighing Terminal **MUST NOT BE USED** in that environment.

	 WARNING
	THE IND360xx ANALOG / IND360xx POWERCELL / IND360xx PRECISION WEIGHING TERMINAL HAS A TEMPERATURE RATING OF T4 (135° C) FOR GAS. IT MUST NOT BE USED IN AREAS WHERE THE AUTO IGNITION TEMPERATURE OF THE HAZARDOUS MATERIAL IS BELOW THIS RATING.

2.7. Division 2 Application Example Using Load Cells

- Note: There are many methods that may be used to install properly approved equipment within hazardous areas. In our example, the non-incendive field circuit parameters (electrical approval data) were compared to those of the load cells connected to make sure the combination is safe. In other applications (specifically in Europe), only a confirmation of a certain IP rating and maximum surface temperature may be required to connect the devices.

The following is an example of applying the IND360xx Analog Weighing Terminal in a Division 2 application connecting a model 2158 Vertex floor scale with 50 feet of load cell cable. The non-incendive field wiring circuit (NIFW) parameters for all devices and cables in the load cell line (including the load cells and junction box) must also be known.

Weighing Terminal model:	IND360xx Analog Weighing Terminal
Base model:	2158 VERTEX® (with approved cells)
Load cell model:	METTLER TOLEDO 0745A
Number of load cells:	4
Load cell cable length:	50 feet
Junction box model:	AJB641SX

IND360xx Analog load cell NIFW parameters from control drawing 30630824:

$$V_{oc} / U_o = 5.14 \text{ VDC}$$

$$I_{sc} / I_o = 222 \text{ mA}$$

$$C_a / C_o = 1 \text{ } \mu\text{F}$$

$$L_a / L_o = 0.43 \text{ mH}$$

Load cell NIFW parameters from model 745A load cell control drawing:

$$V_{max} = 25 \text{ VDC}$$

$$I_{max} = 600 \text{ mA}$$

$$C_i = 0 \text{ } \mu\text{F}$$

$$L_i = 29 \text{ } \mu\text{H}$$

Default load cell cable values:

$$C_{\text{cable}} = 60 \text{ pF / foot}$$

$$L_{\text{cable}} = 0.2 \text{ } \mu\text{H / foot}$$

The 2158 junction box is considered to be a simple apparatus. The 2158 is completely passive and has no components capable of storing energy, so no NIFW parameters are associated with it.

Now, compare these values using the formulas provided in the previous section of this chapter and determine if all four criteria pass or fail.

- Note that the NIFW parameters for capacitance and inductance of the load cell must be multiplied by the quantity of load cells used. Also note that the field circuit parameters for the load cell cable must be multiplied by the total load cell cable length.

Formula	Pass or Fail
U_i / V_{max} must be $\geq U_o / V_{\text{oc}}$ $25 \text{ VDC} \geq 5.14 \text{ VDC}$	PASS
I_i / I_{max} must be $\geq I_o / I_{\text{sc}}$ $600 \text{ mA} \geq 222 \text{ mA}$	PASS
$C_i + C_{\text{cable}} \geq C_a$ $C_i = 0 \text{ } \mu\text{F} * 4 \text{ cells} = 0 \text{ } \mu\text{F}$ (load cells) $C_i = 0 \text{ } \mu\text{F}$ (junction box) $C_{\text{cable}} = 60 \text{ pF / foot} * 50 \text{ feet} = 3000\text{pF} = 0.003 \text{ } \mu\text{F}$ $(0 \text{ } \mu\text{F} + 0 \text{ } \mu\text{F} + 0.003 \text{ } \mu\text{F}) \leq 1 \text{ } \mu\text{F}$	PASS
$L_i + L_{\text{cable}} \leq L_a / L_o$ $L_i = 29 \text{ } \mu\text{H}$ (load cells) * 4 cells = 0.116 mH $L_i = 0 \text{ } \mu\text{H}$ (junction box) $L_{\text{cable}} = 0.2 \text{ } \mu\text{H / foot} * 50 \text{ feet} = 10 \text{ } \mu\text{H} = 0.01\text{mH}$ $(0.116 \text{ mH} + 0 \text{ mH} + 0.01 \text{ mH}) \leq 0.43 \text{ mH}$	PASS

In addition to the formulas above, the temperature rating of the IND360xx Analog / IND360xx POWERCELL / IND360xx Precision Weighing Terminal must be checked against the AIT (Auto Ignition Temperature) of the hazardous product. For this example, the hazardous product has an AIT of 200°C (393°F), which is higher than the rating of the IND360xx Analog / IND360xx POWERCELL / IND360xx Precision Weighing Terminal approval value of 85°C (203°F) for dust and 100°C (211°F) for gas. This indicates the temperature comparison test passes.

Since all four NIFW parameters compare favorably and pass the formula evaluation and the temperature comparison test passes, the load cells listed in this example may be safely installed into a Division 2 area. All equipment must be installed according to their corresponding control drawing using all pertinent local and national codes and regulations.

2.8. Installation Procedure

Once the information in this chapter and in all other suggested regulatory documents has been read and understood, the IND360xx Analog / IND360xx POWERCELL / IND360xx Precision Weighing Terminal may be installed.

Special installation requirements for the IND360xx Analog / IND360xx POWERCELL / IND360xx Precision Weighing Terminals are described below. These are also listed in Section 3.3, **Special Conditions of Use**, in this manual.

In addition to the information in this chapter, instructions, control drawings, installation drawings and details listed in the certificates found in Chapter 3 and Appendix A of this manual must be followed during the installation.

2.8.1. Installation Requirements for the IND360xx

IND360 Harsh version permits the connection through the glands of cables with diameters between 4 and 10 mm. When tightening the glands of terminal connections, it is recommended that 7 NM of torque be used. The recommended conductor insulation stripping length is 7mm.

When commissioning the IND360, the connection labels on the DIN/Panel overlay or Harsh enclosure shall be followed.

The conductor cross section of cable should correspond to the requirement noted in the terminal datasheet. For example, 0.15mm² – 1.5mm² for Phoenix MC1.5 / 6-ST - 3.5. The connection should be torqued to between 0.22Nm and 0.25Nm. Once the conductor is fixed, check that the connection is not loose by tugging on the cable.

The conduit or Ex cable glands installed in the terminal are assessed according to, and follow, Ex hazardous install requirements. When replacing conduit or cable glands, please select cable glands that are properly Ex certified and rated according to the installation manual.

There are many methods that may be used to install properly approved equipment within hazardous areas. In some cases, the field circuit characteristics (electrical approval data) must be compared to those of the device connected to make sure the combination is safe. In other situations, only a confirmation of a specific IP rating, nominal supply voltage and current and/or maximum surface temperature may be required to connect the devices.

METTLER TOLEDO claims no expertise with respect to all the electrical regulations that may be in effect at any specific location. You must refer to a national and/or local electrical standard handbook for an installation that conforms to all required standards.

The IND360xx Harsh AC version includes an unterminated line cord (without plug). The line cord must be terminated as defined by national and/or local electrical standards to meet all required standards.

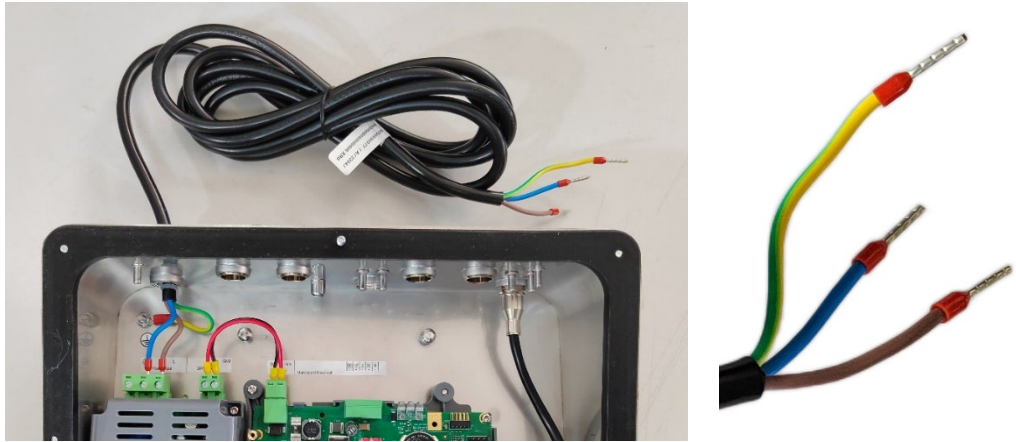

Figure 2-1: Unterminated Line Cord

2.8.1.1. Line Cord Wiring Color Code

Color	Connection
Yellow/Green	Ground (PE)
Brown	Line (L)
Blue	Neutral (N)

3 Special Requirements

When an IND360xx Analog / IND360xx POWERCELL / IND360xx Precision Weighing Terminal is installed inside a hazardous area, some special requirements must be considered. This chapter discusses these items.

3.1. Enclosure

A certified enclosure with a minimum ingress protection rating of IP54 of IND360xx DIN version is required for installation. A certified enclosure with a minimum ingress protection rating of IP54 is required for installation according to the approval.

3.2. Areas with Different Classifications

The IND360xx Analog / IND360xx POWERCELL / IND360xx Precision Weighing Terminal has been approved for use with load cells located in an area classified as Division 2 or as Zone 2. This approval DOES NOT mean that the IND360xx Analog / IND360xx POWERCELL / IND360xx Precision Weighing Terminal can be used in or connected directly to equipment located in Division 1, Zone 0/1 or Zone 20/21 areas. Different precautions must be taken when installing equipment into these areas. METTLER TOLEDO offers other Weighing Terminals for use in Division 1, Zone 0/1 or Zone 20/21 areas.

3.3. Special Conditions of Use

To prevent ignition of flammable or combustible atmosphere, disconnect power before servicing.

3.3.1. For DIN

Schedule of limitations

1. For Ex ec applications the IND360 DIN versions requires an enclosure that meets the requirements of at least IP54 following the thermal conditioning and impact tests of ANSI/UL 60079-0.
2. The equipment shall only be used in an area of pollution degree 1 & 2, as defined in IEC 60664-1.
3. Transient protection shall be provided that is set at a level not exceeding 140% of the peak rated voltage value at the supply terminals to the equipment.
4. Must be installed in a tool secured final equipment enclosure.

- The service temperature range of the IND360 DIN versions is -10°C to 70°C .

3.3.2. For PANEL



Specific conditions of use

- The IND360 Panel versions require installation in a final equipment enclosure in compliance with, mounting, spacing and segregation requirements of the ultimate application, including the use of a tool secured cover.

3.3.3. For HARSH

Specific conditions of use

- Parts of the enclosure are constructed of plastic and may constitute an electrostatic discharge hazard. The risk of electrostatic discharge shall be minimized at installation, following the direction given in the instruction manual and clean only with a damp cloth.
- Transient protection shall be provided that is set at a level not exceeding 140% of the peak rated voltage value at the supply terminals to the equipment.
- The equipment shall only be used in an area of at least pollution degree 2, as defined in IEC 60664-1.
- The enclosure must be protected from sunlight and sources of UV light.

	 WARNING
	<p>THE IND360xx ANALOG / IND360xx POWERCELL / IND360xx PRECISION WEIGHING TERMINAL MUST BE INSTALLED AND MAINTAINED PER THE ABOVE SPECIAL CONDITIONS WITHOUT EXCEPTION. FAILURE TO DO SO COULD RESULT IN BODILY HARM AND/OR PROPERTY DAMAGE.</p>

A. Approval Documents

A.1. Approval Documents

A.1.1. United States

FM Approvals LLC has investigated the IND360xx Analog / IND360xx POWERCELL / IND360xx Precision Weighing Terminal and issued a Certificate of Compliance indicating compliance to the U.S. requirements for a Division 2 and Zone 2/22 Associated NIFW apparatus. The certificate for this approval can be found at <https://www.mt.com/us/en/home/search/compliance.html>

A.1.2. Canada

FM Approvals LLC has investigated the IND360xx Analog / IND360xx POWERCELL / IND360xx Precision Weighing Terminal and issued a Certificate of Compliance indicating compliance to Canadian requirements for a Division 2 and Zone 2 NIFW / Associated NIFW Apparatus. The certificate for this approval can be found at <https://www.mt.com/us/en/home/search/compliance.html>

A.1.3. Control Drawing (U.S. and Canada)

In order to meet the U.S. and Canadian Division 2 requirements, control drawings 30630824, 30630826 and 30630828 are provided. Review this drawing before installation. If there are any questions regarding the details in the control drawing, please contact the local METTLER TOLEDO representative. Refer to sections A.2 and A.3 for the drawing.

A.1.4. Europe (ATEX/UKEX)

FM. has issued a Type Examination Certificate indicating compliance of the IND360xx Analog / IND360xx POWERCELL / IND360xx Precision Weighing Terminal with European requirements for Essential Health and Safety Requirements and the ATEX directive 2014/34/EU for Category 3 equipment. Review this certificate for details of the approval. The certificate for this approval can be found at <https://www.mt.com/us/en/home/search/compliance.html>

A.1.5. Global and International (IECEx)

FM. has issued an IECEx Certificate of Conformity indicating compliance of the IND360xx Analog / IND360xx POWERCELL / IND360xx Precision Weighing Terminal with IECEx Certification Scheme for Explosive Atmospheres. Review this certificate for details of the approval. The certificate for this approval can be found at <https://www.mt.com/us/en/home/search/compliance.html>

A.1.6. Installation Drawing (ATEX/UKEX and IECEx)

An ATEX/IECEx installation drawing was created to assist when installing the IND360xx Analog / IND360xx POWERCELL / IND360xx Precision into Zone 2/22 areas. This drawing is a guide for installation and connection of the IND360xx Analog / IND360xx POWERCELL / IND360xx Precision Weighing Terminal when used in a Zone 2 or Zone 22 hazardous area based on the ATEX or IECEx approval. Review this drawing

before installation. If there are any questions regarding the details in the drawing, please contact the local METTLER TOLEDO representative. Refer to sections A.4 and A.6 for the drawing.

A.2. Control Drawing (US and Canada), Analog

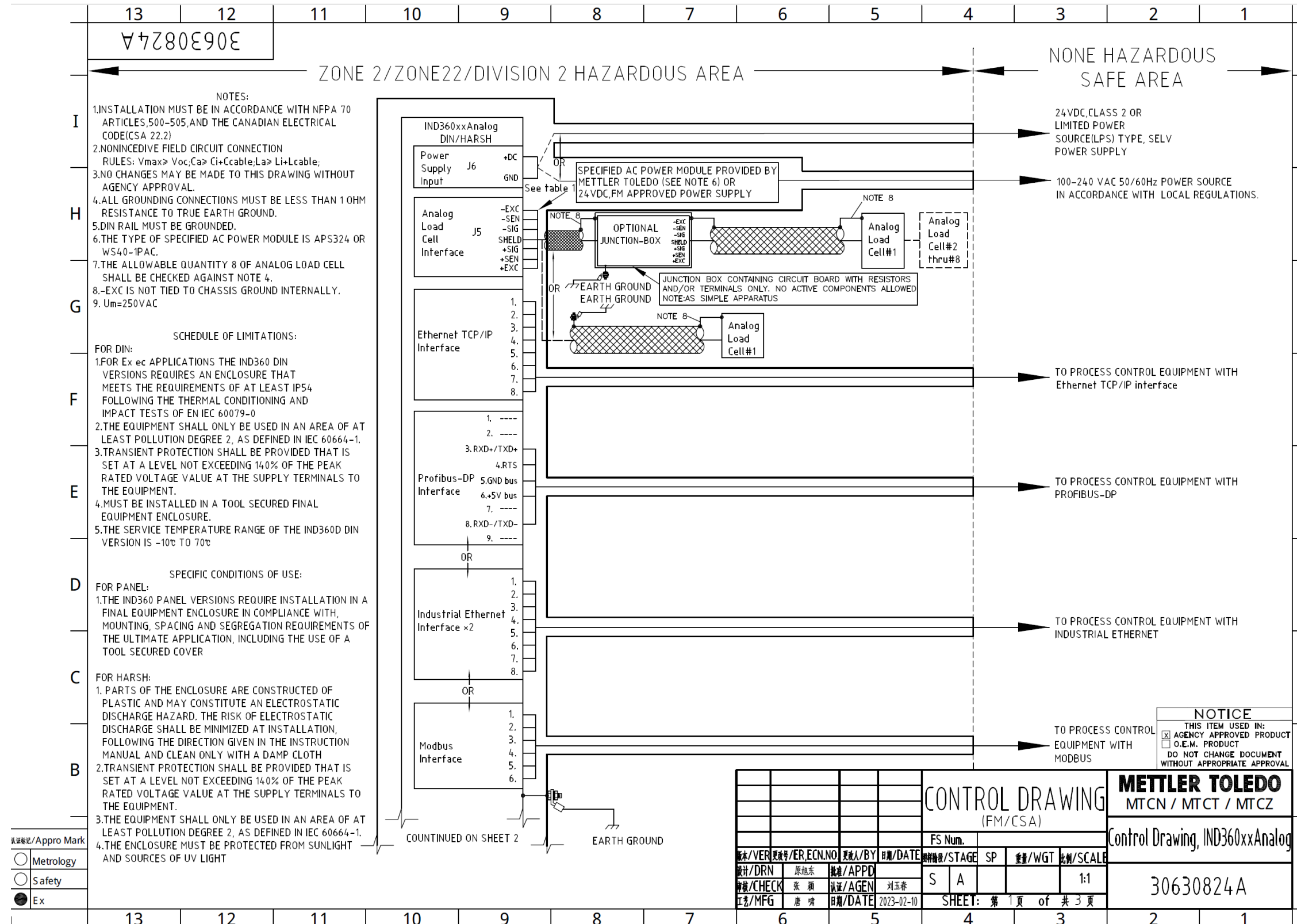

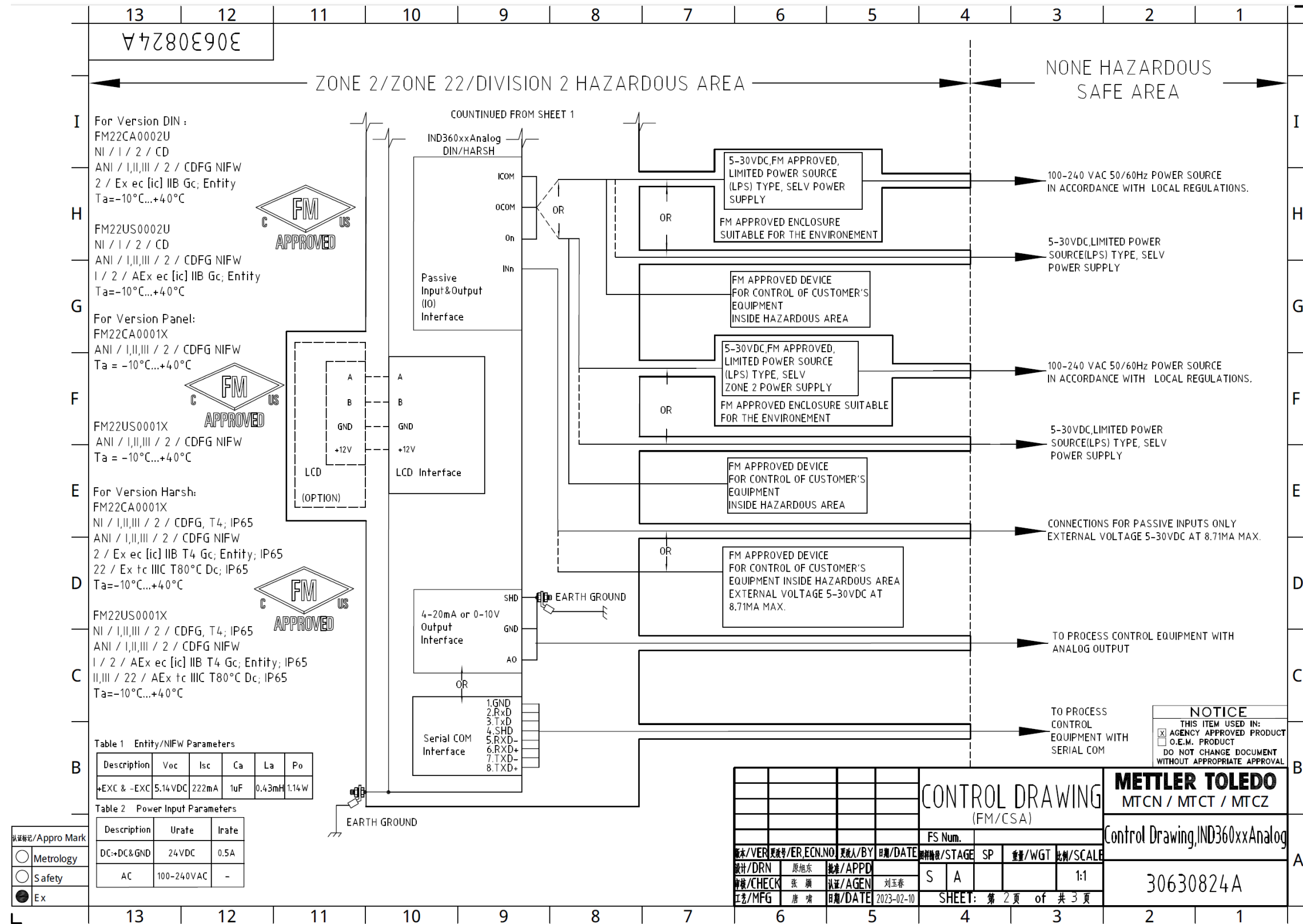

认证/Appro Mark	
○ Metrology	
○ Safety	
● Ex	

Table 1 Entity/NIFW Parameters

Description	Voc	Isc	Ca	La	Po
+EXC & -EXC	5,14VDC	222mA	1uF	0,43mH	1,14W

Table 2 Power Input Parameters

Description	Urate	Irate
DC:+DC&GND	24VDC	0,5A
AC	100-240VAC	-

CONTROL DRAWING (FM/CSA)				FS Num.	
设计/DRN	原地东	批准/APPD	日期/DATE	审核/STAGE	SP
检查/CHECK	张颖	认证/AGEN	刘玉春	S	A
工艺/MFG	唐瑞	日期/DATE	2023-02-10	SHEET: 第 2 页 of 共 3 页	

NOTICE
THIS ITEM USED IN:
 AGENCY APPROVED PRODUCT
 O.E.M. PRODUCT
DO NOT CHANGE DOCUMENT WITHOUT APPROPRIATE APPROVAL

METTLER TOLEDO
MTCN / MTCT / MTCZ
Control Drawing,IND360xxAnalog
30630824A

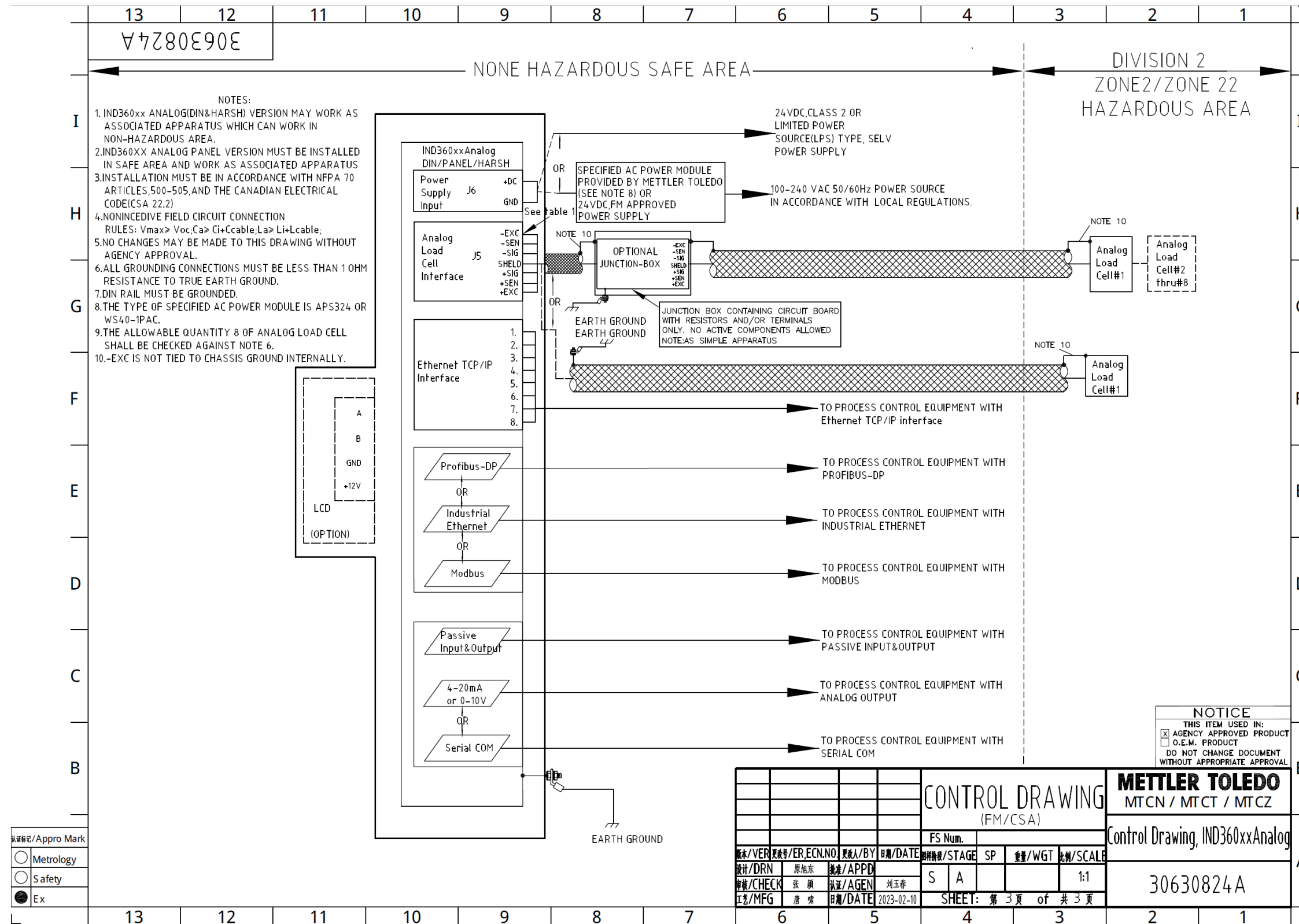

A.3. Control Drawing (US and Canada), POWERCELL

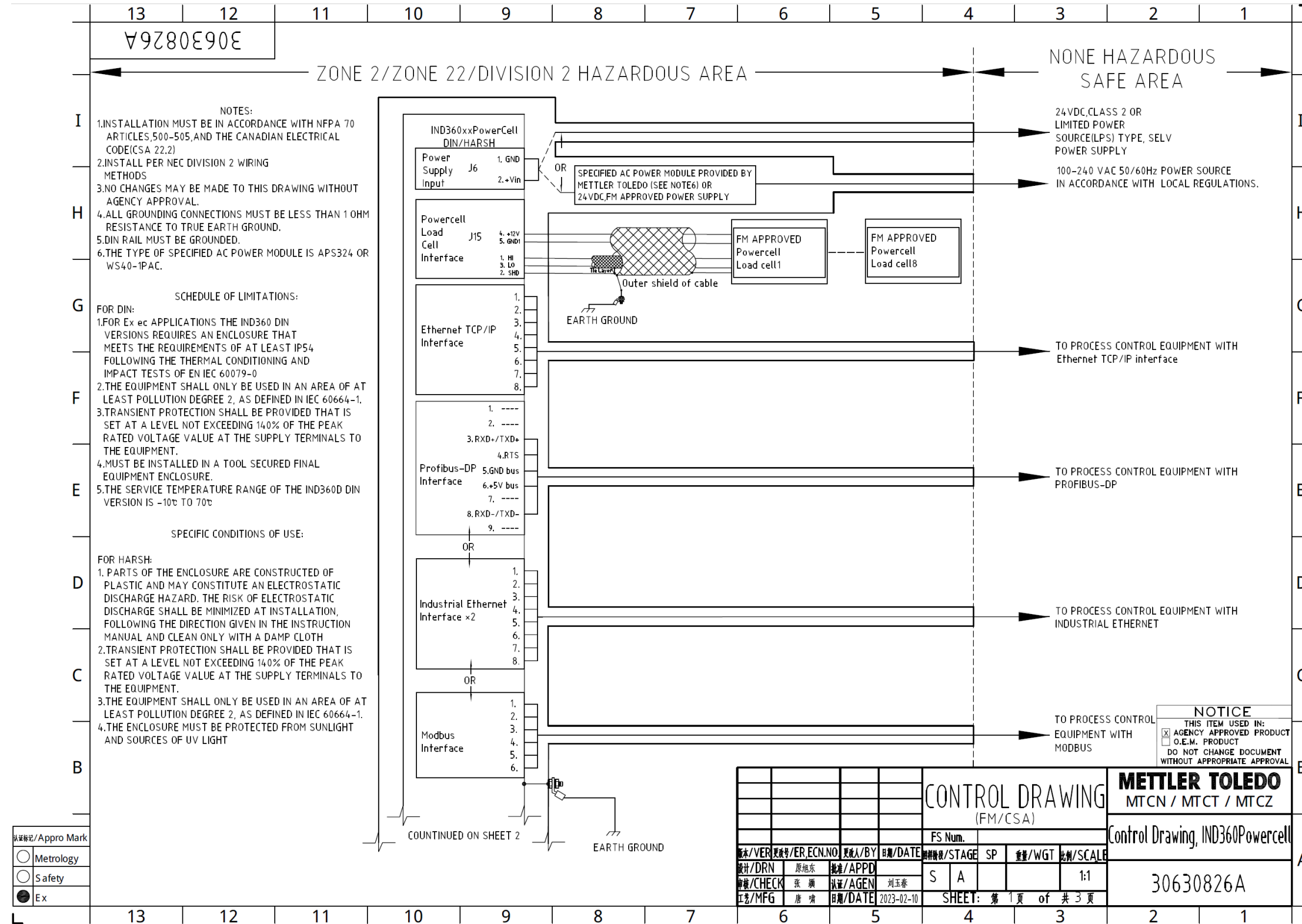

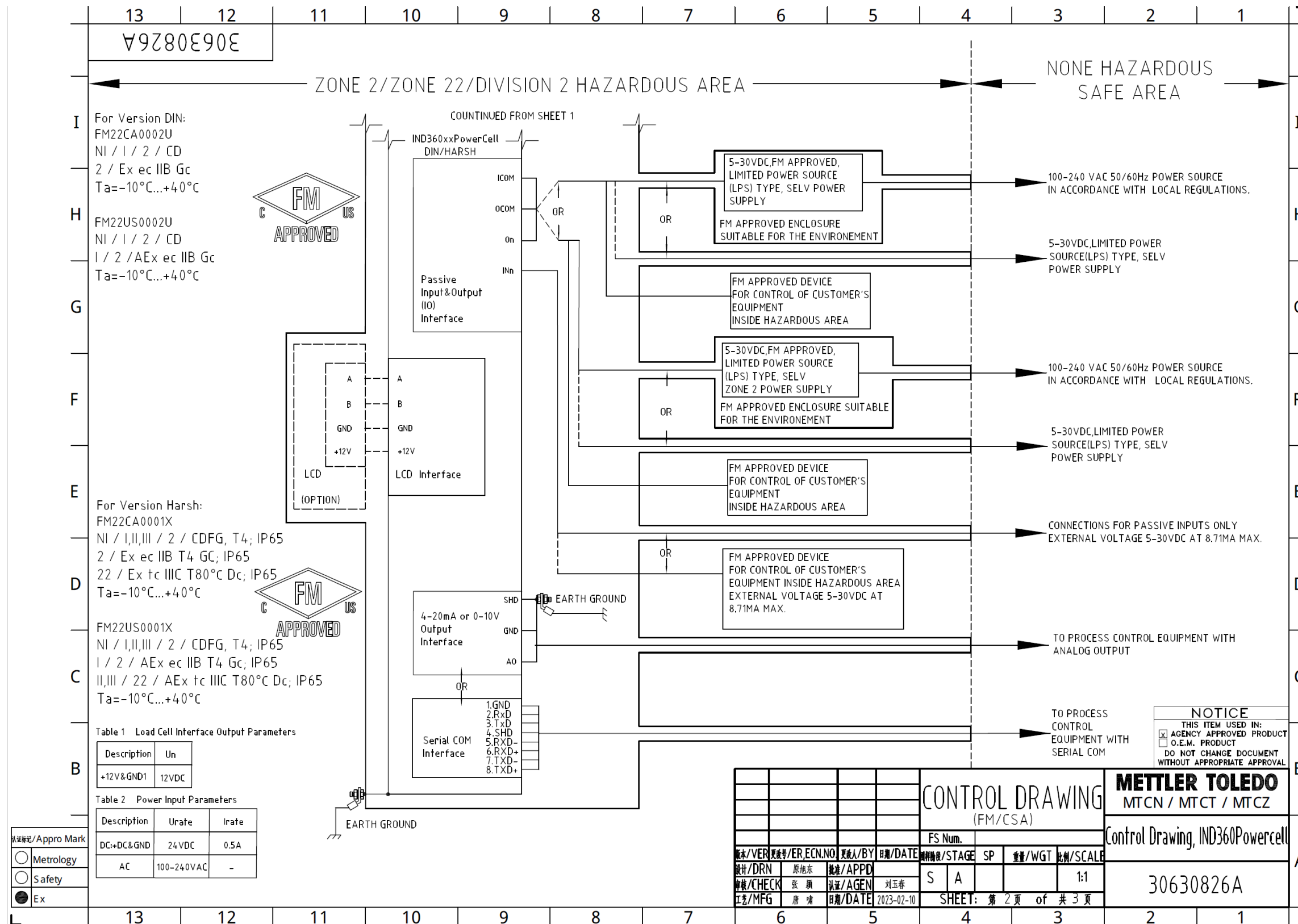

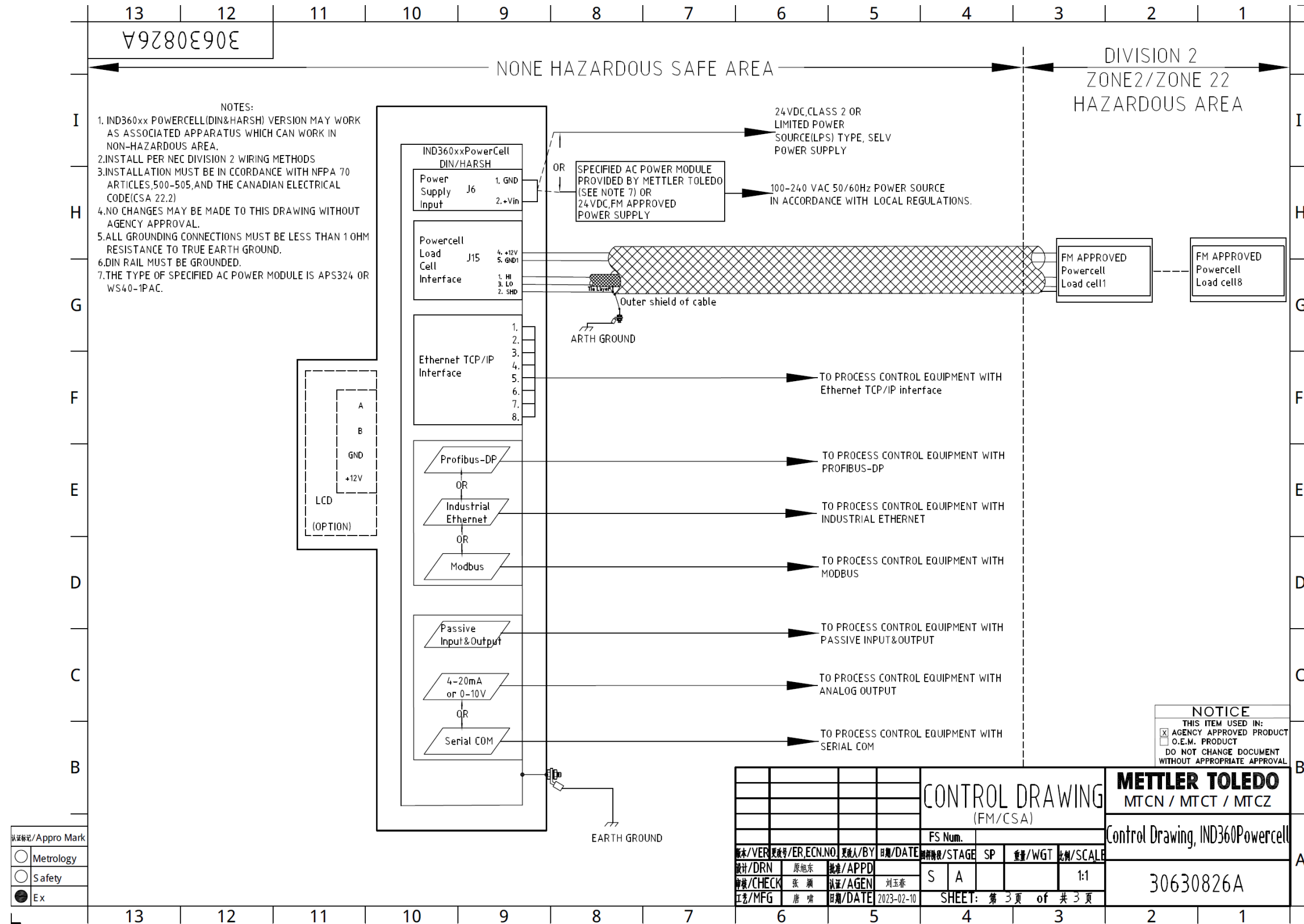

A.4. Control Drawing (US and Canada), Precision

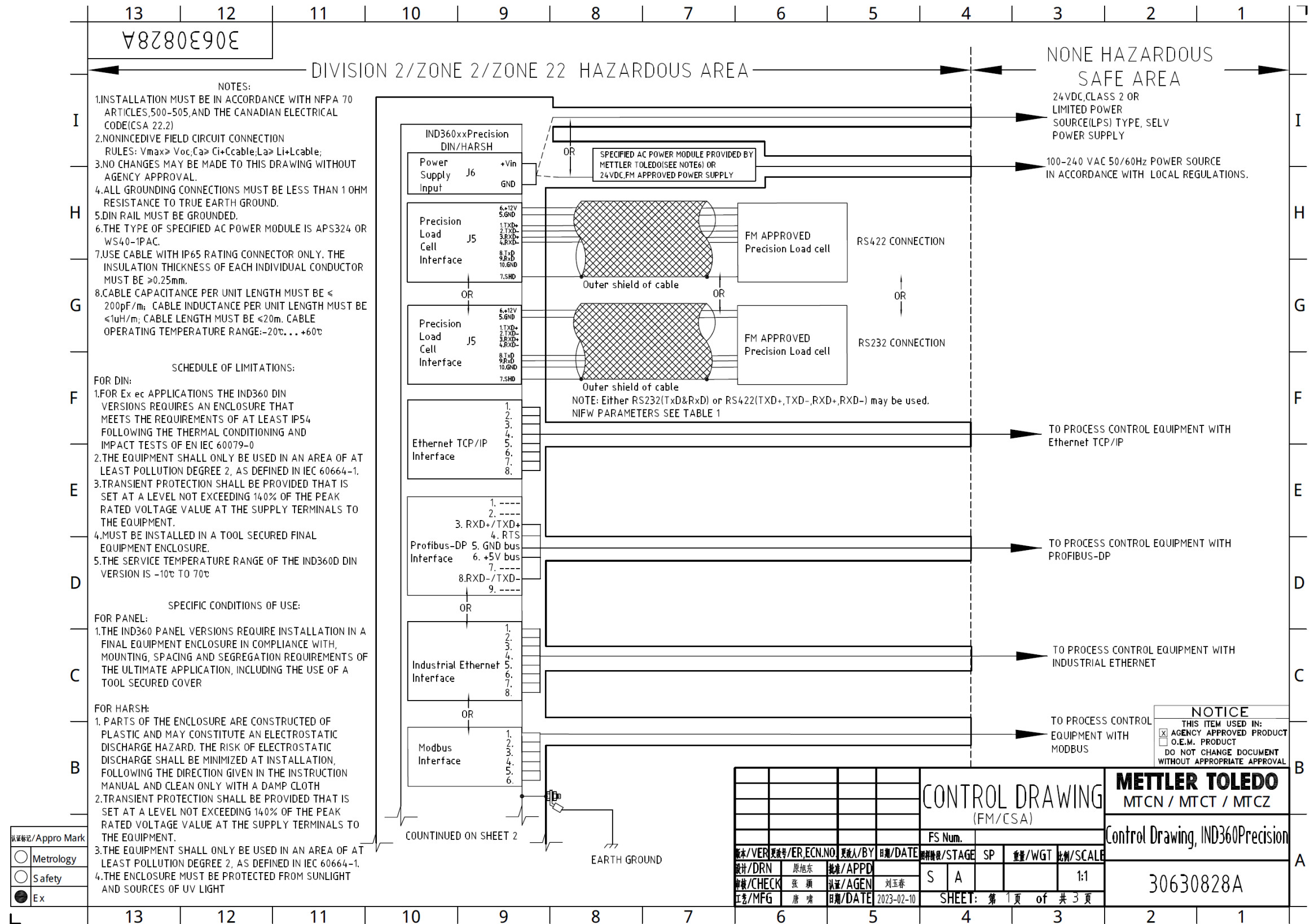

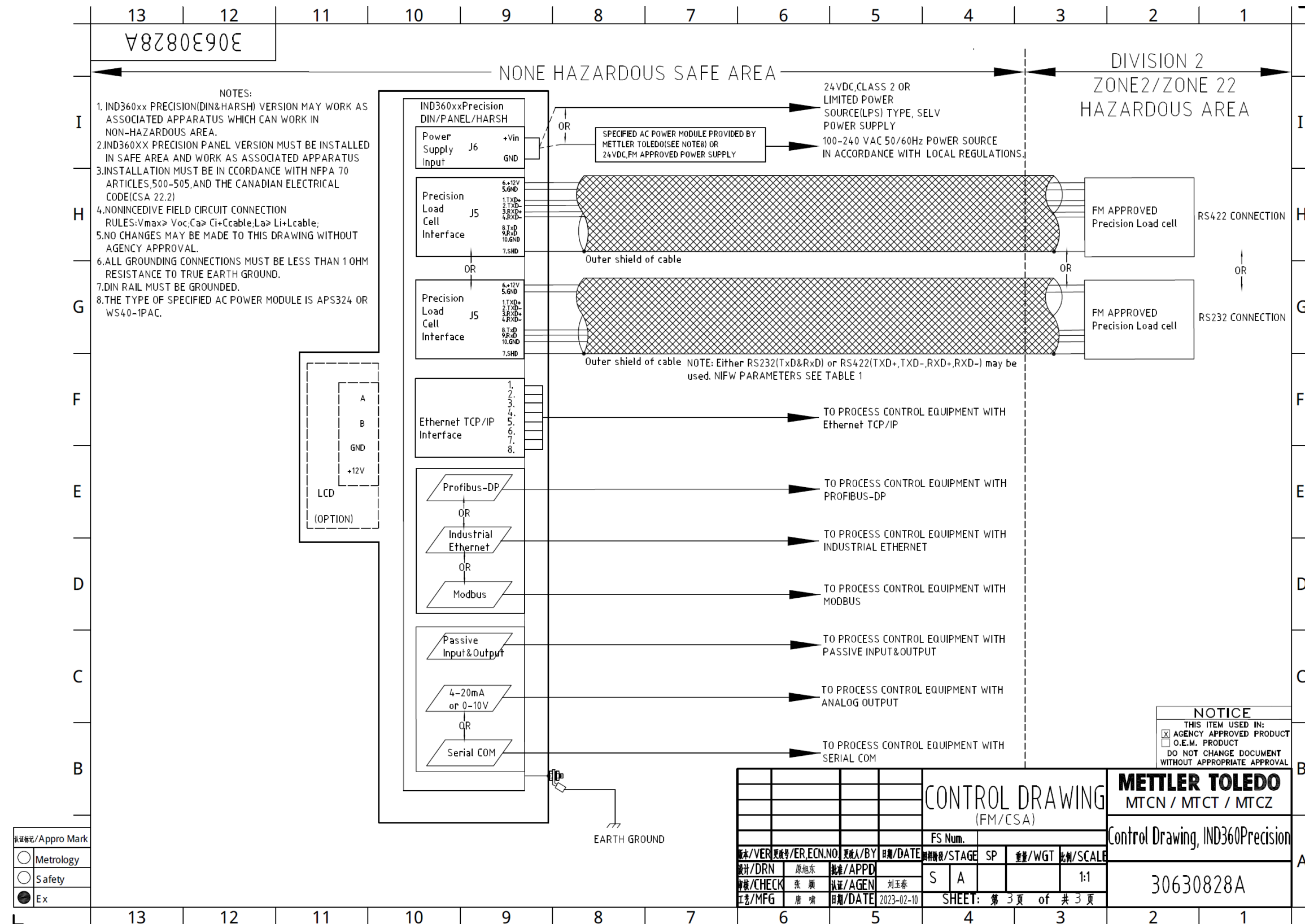

A.5. Global and International (ATEX/UKEX and IECEx), Analog

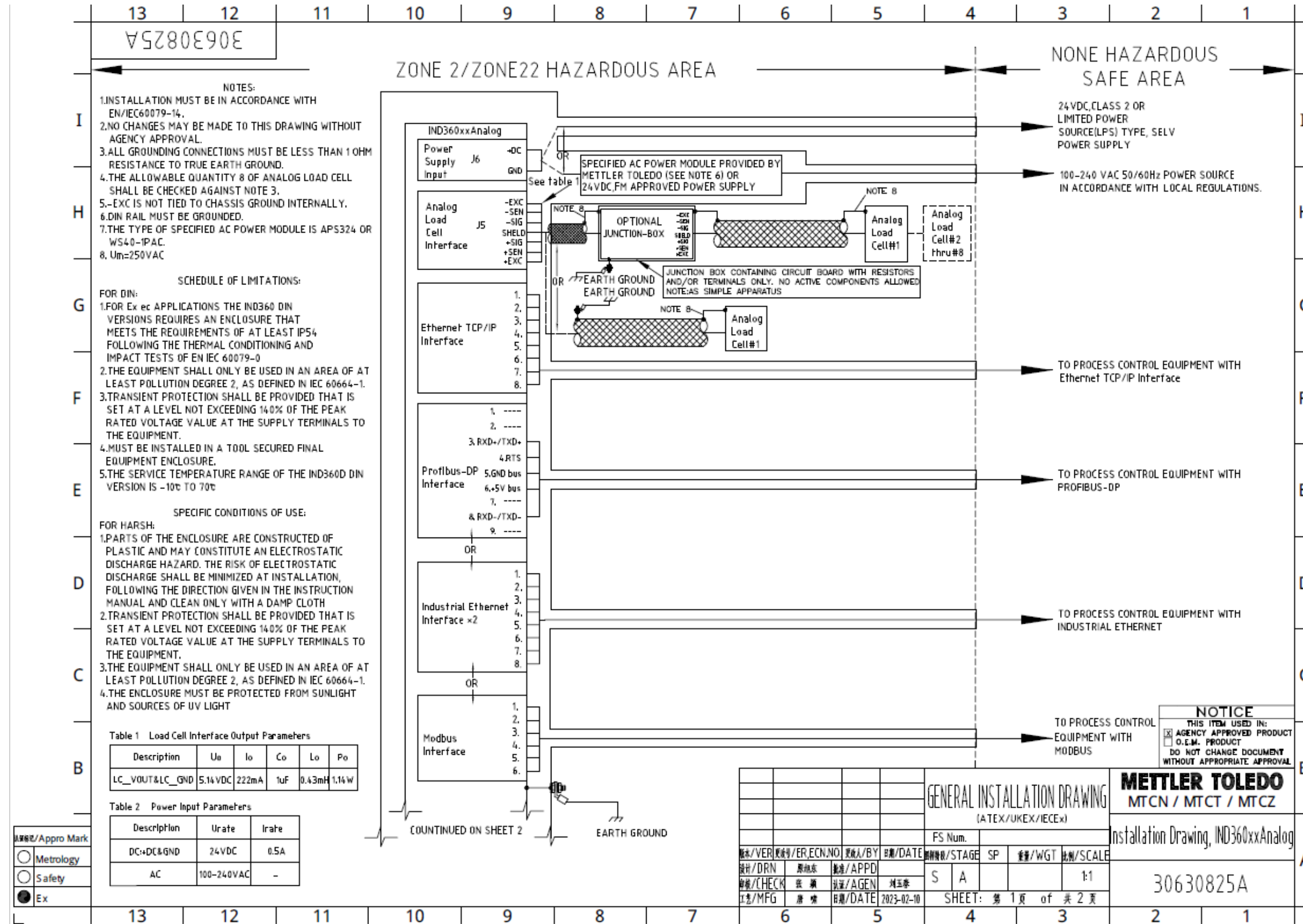

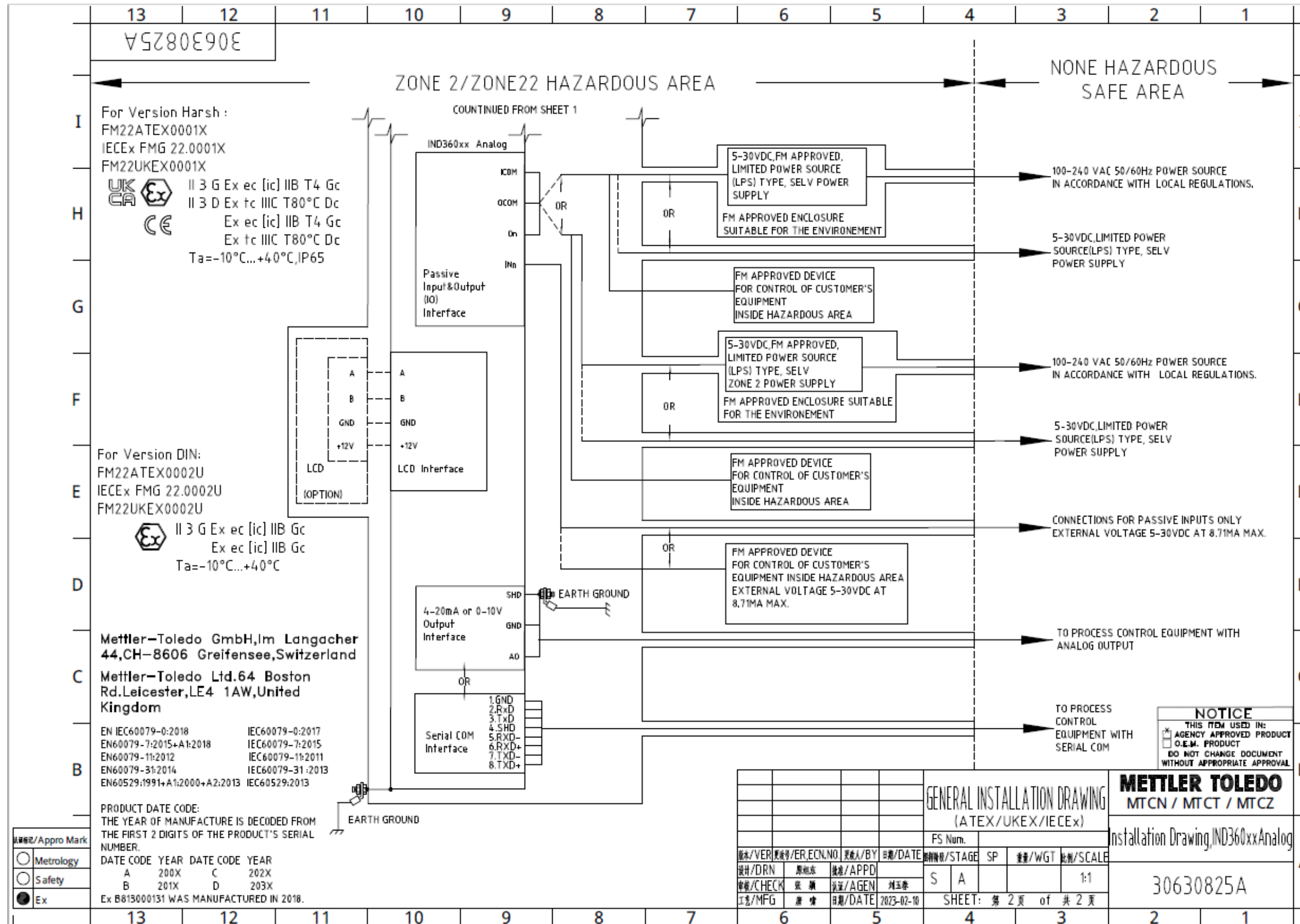

A.6. Global and International (ATEX/UKEX and IECEx), POWERCELL

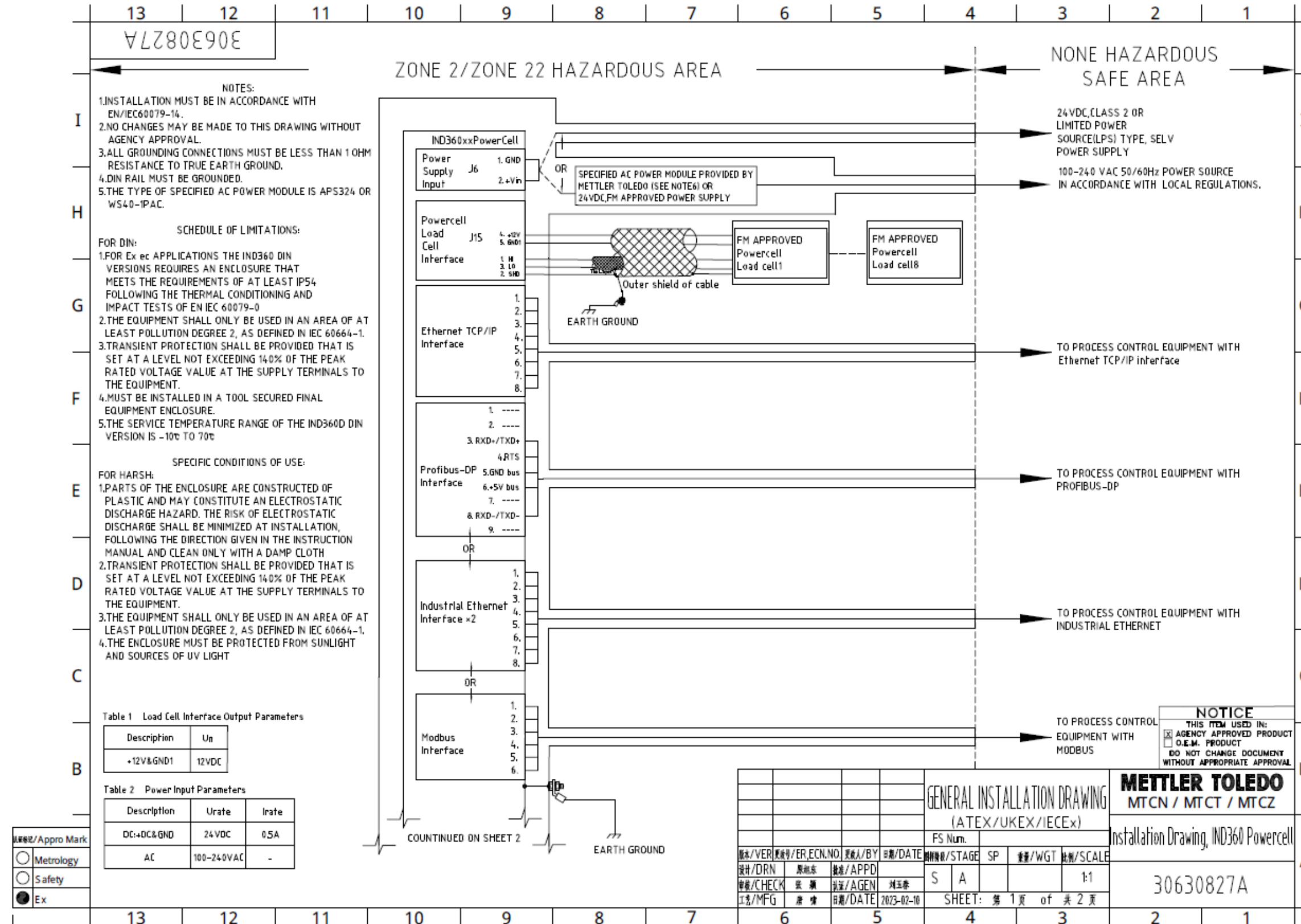

A.7. Global and International (ATEX/UKEX and IECEx), Precision

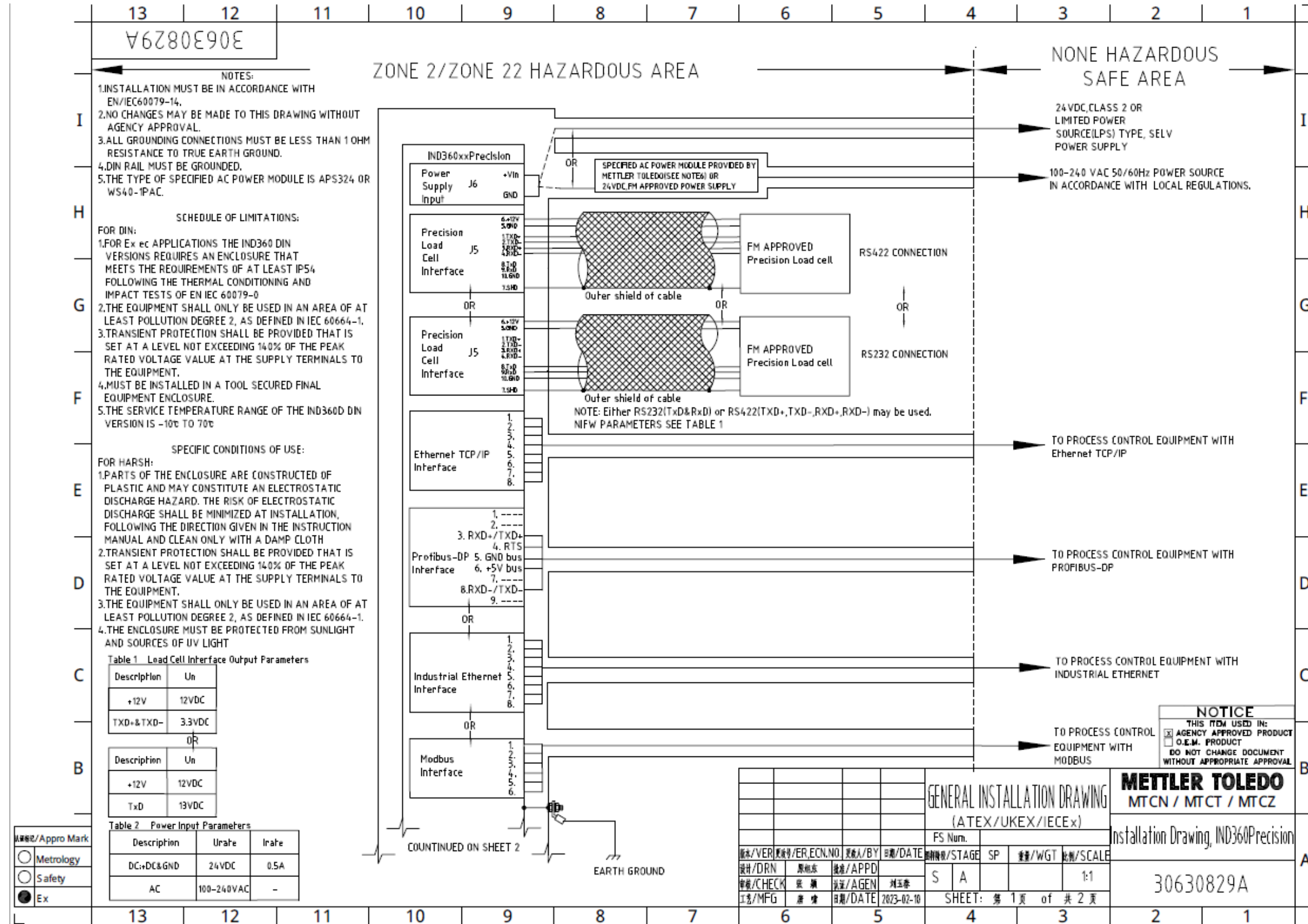

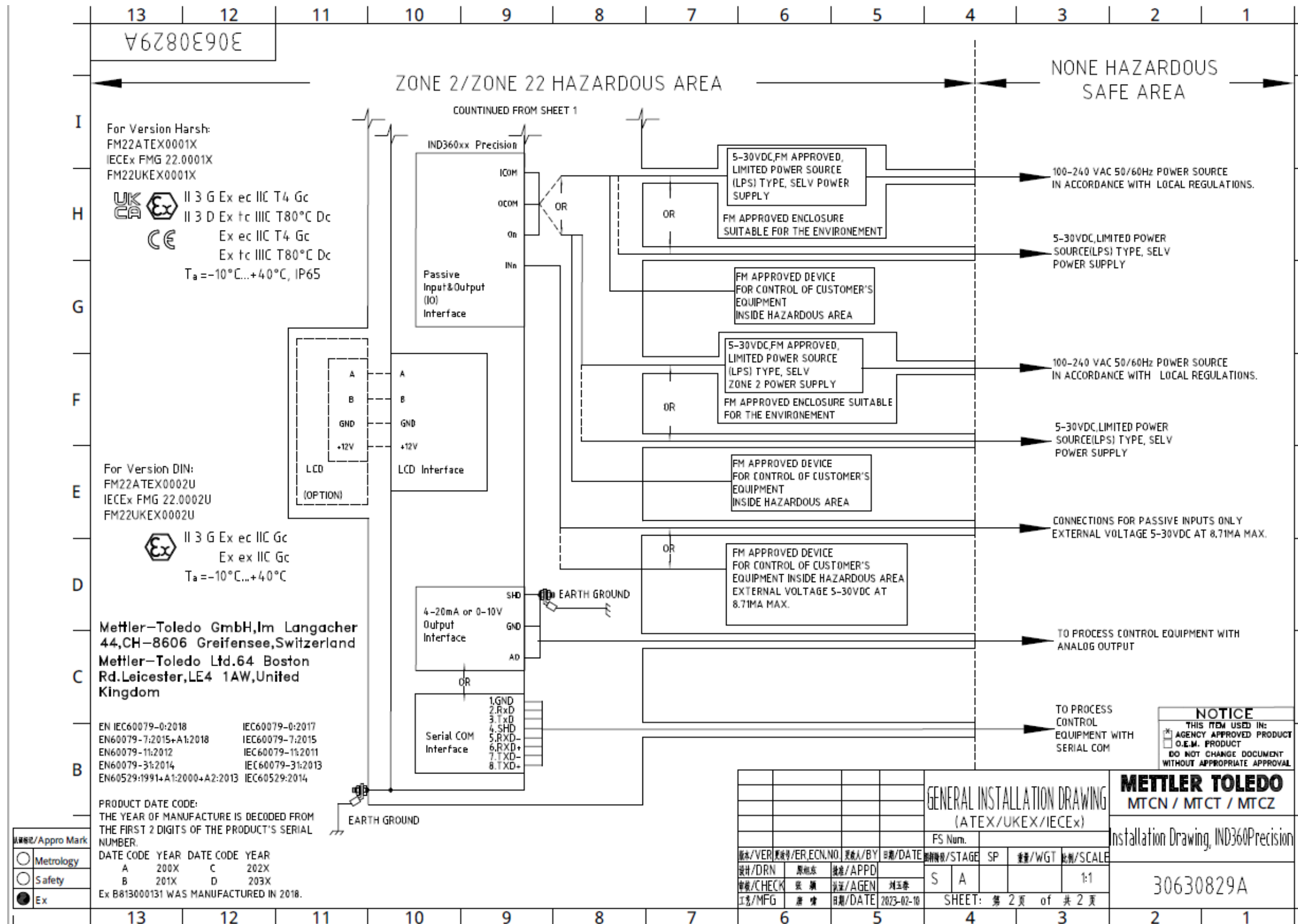

METTLER TOLEDO Service

To protect your product's future:

Congratulations on choosing the quality and precision of METTLER TOLEDO. Proper installation according to these instructions, while put into service, installation and operate need to do according to the manual, regular calibration or adjustment, assembling and dismantling and maintenance should be supported by our factory-trained service team ensure dependable and accurate operation, protecting your investment. Contact us about a service agreement tailored to your needs and budget.

We invite you to register your product at www.mt.com/productregistration so we can contact you about enhancements, updates and important notifications concerning your product.

www.mt.com/ind-IND360-downloads

For more information

Mettler-Toledo, LLC
1900 Polaris Parkway
Columbus, OH 43240

Mettler-Toledo GmbH
Im Langacher44,
CH-8606 Greifensee,
Switzerland.

30678838 Rev. 3, 12/2023

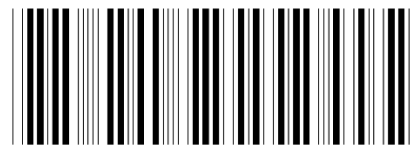

30678838